

B 60 Serisi

www.beymetal.com.tr

B 60

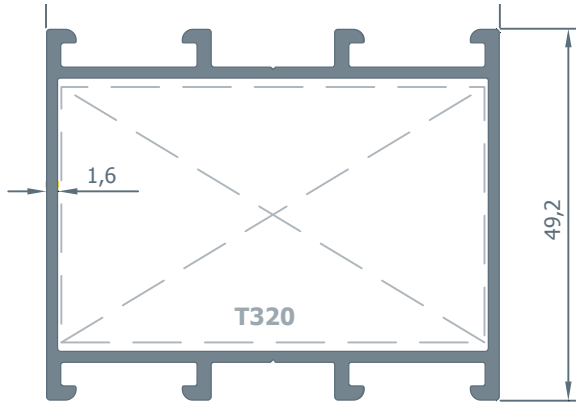



1980

Kasa Profili
1.125 kg/m.

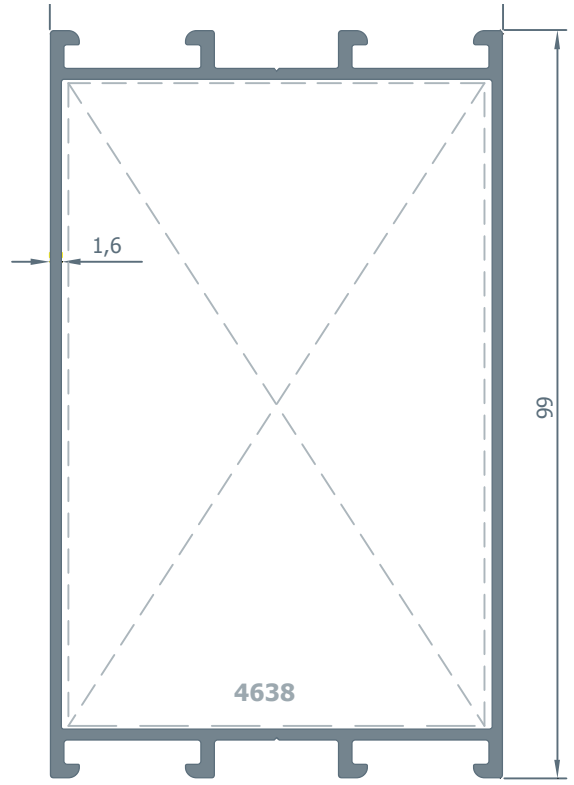

1984

Genis Kasa Profili
1.556 kg/m.

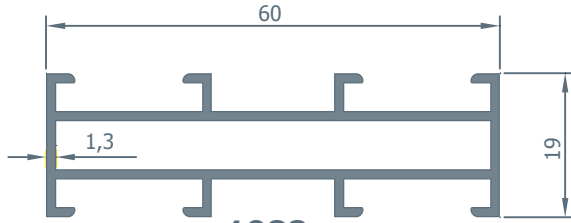

1988

Dar Kasa Profili
0.678 kg/m.

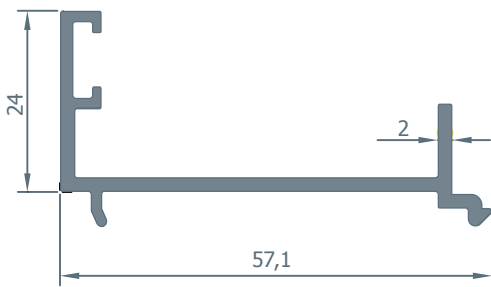

1987

Kasa Adaptör Profili
0.556 kg/m.

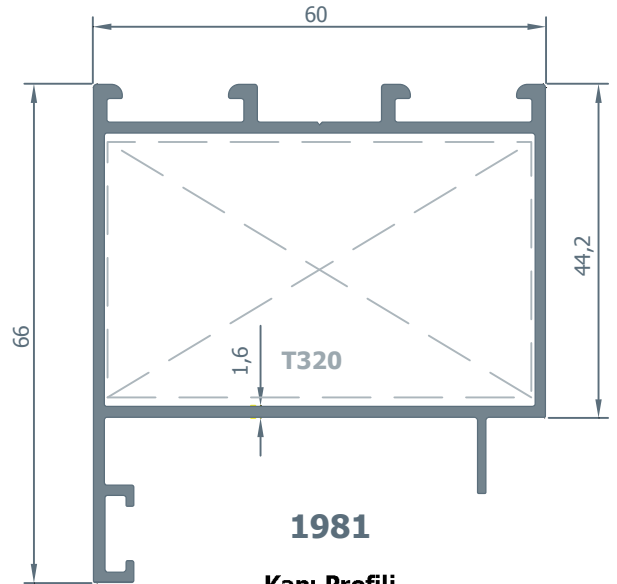

1981

Kapı Profili
1.152 kg/m.

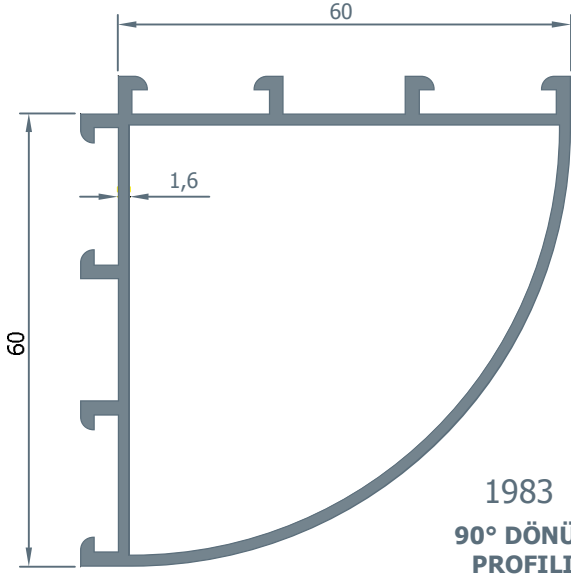

1983
90° DÖNÜŞ
PROFİLİ
1.195 kg/m.

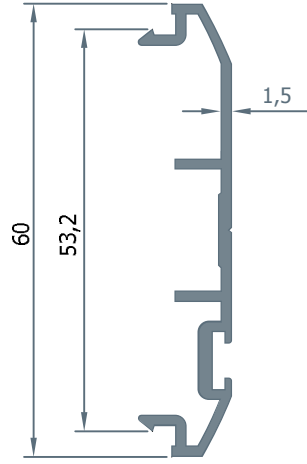

4237
ÇARPMA KAPI
ADAPTÖR
0.440 kg/m.

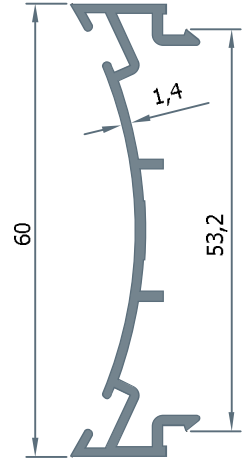

4238
ÇARPMA KAPI
ADAPTÖR
0.470 kg/m.

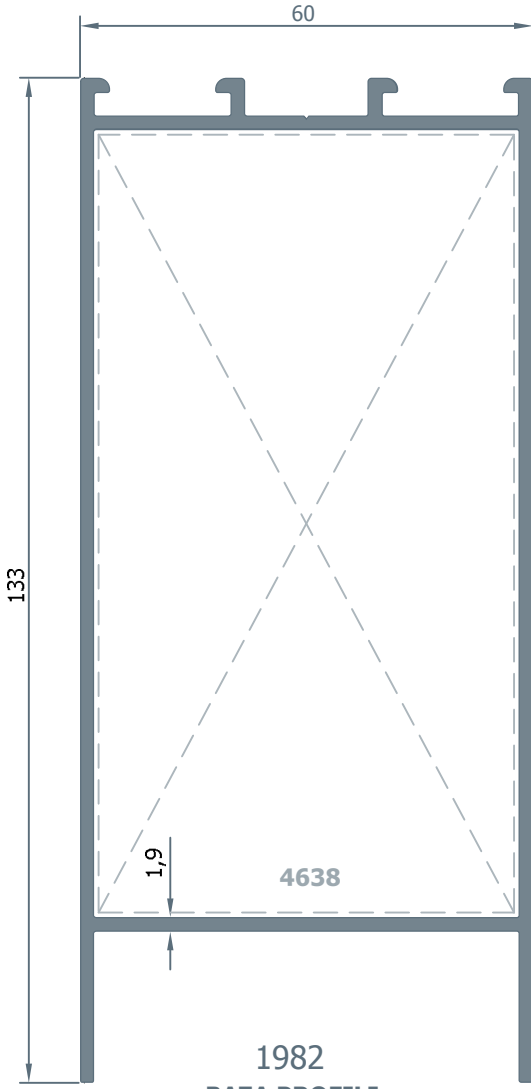

1982
BAZA PROFİLİ
2.043 kg/m.

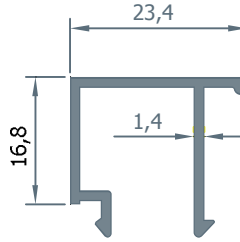

1986
CAM ÇİTASI
0.266 kg/m.

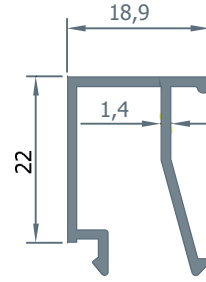

1985
CAM ÇİTASI
0.293 kg/m.

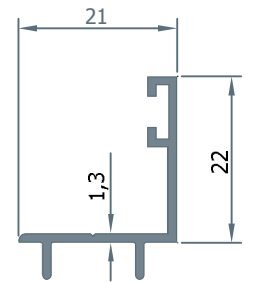

1990
"L" ÇİTA
0.206 kg/m.

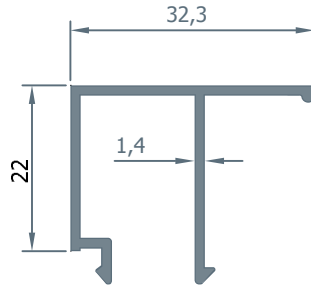

1991
CAM ÇİTASI
0.338 kg/m.

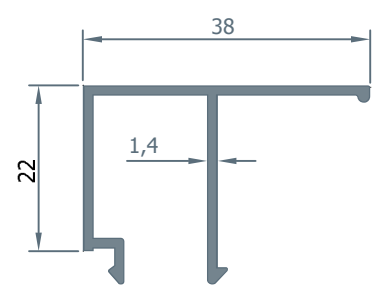

1992
CAM ÇİTASI
0.360 kg/m.

KASA - KANAT DETAYI

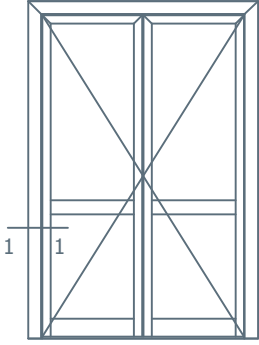

1.1 Detayı
Details

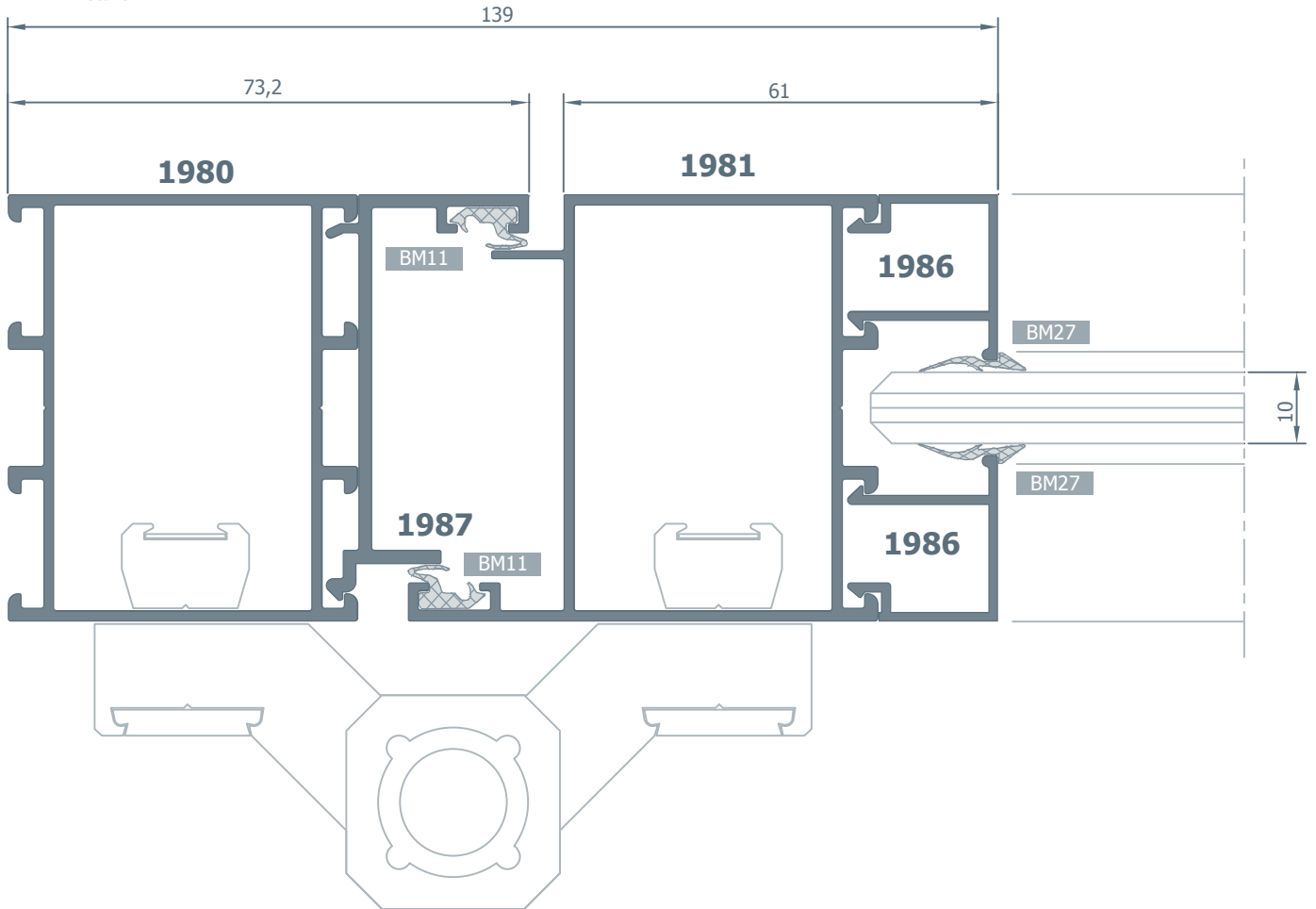

ORTA KAYIT - ETEK PROFİLİ DETAYI

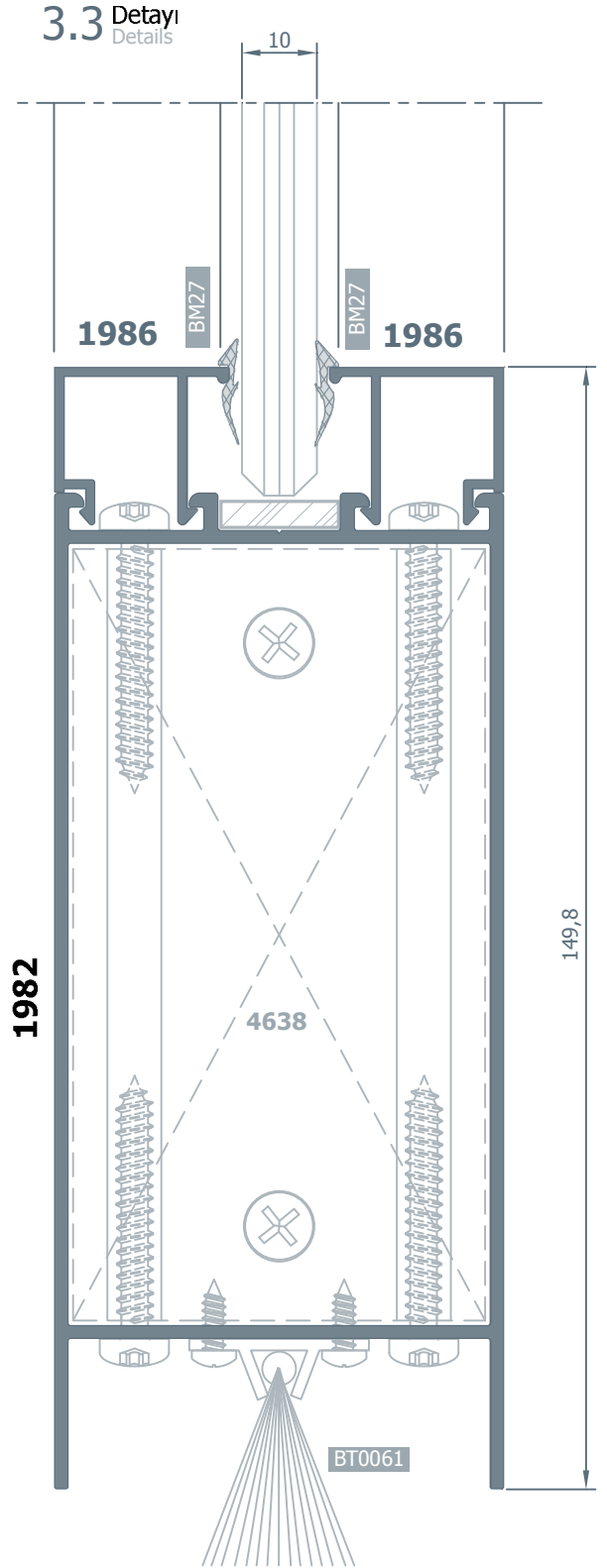
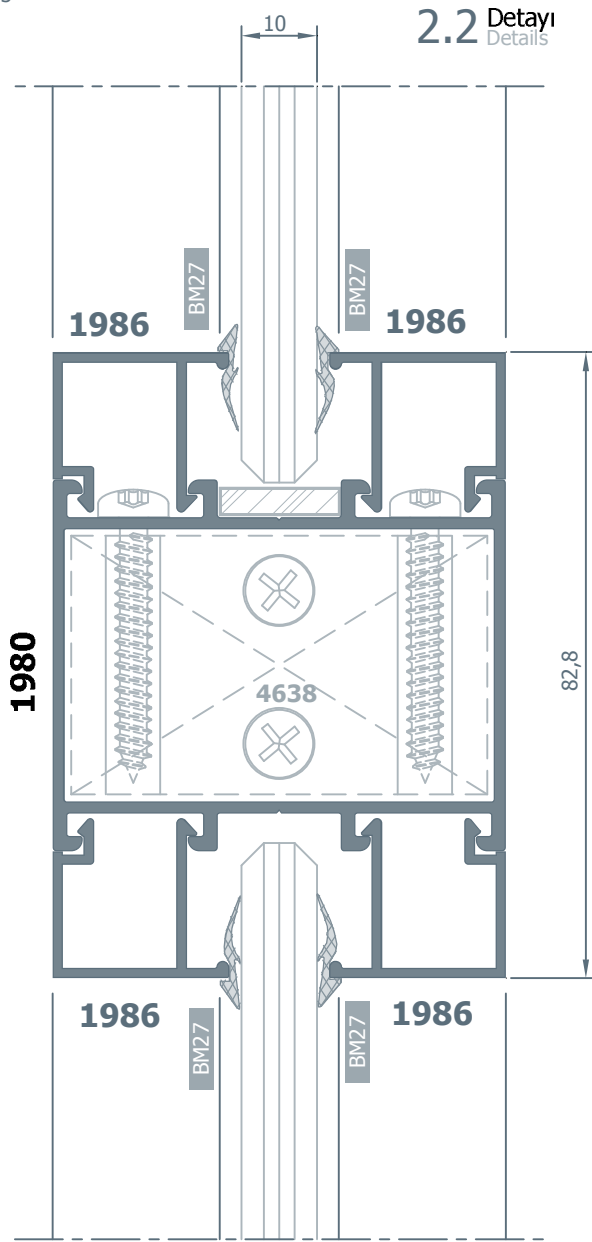
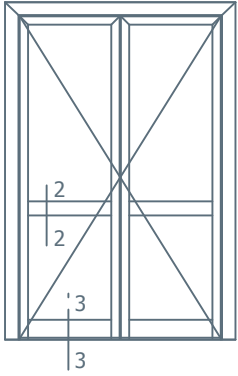

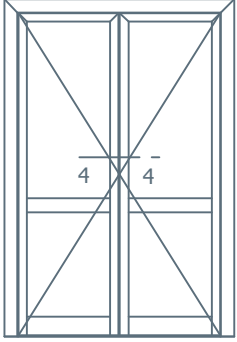

ÇİFT KANAT KAPI DETAYI

4.4 Detayı
Details

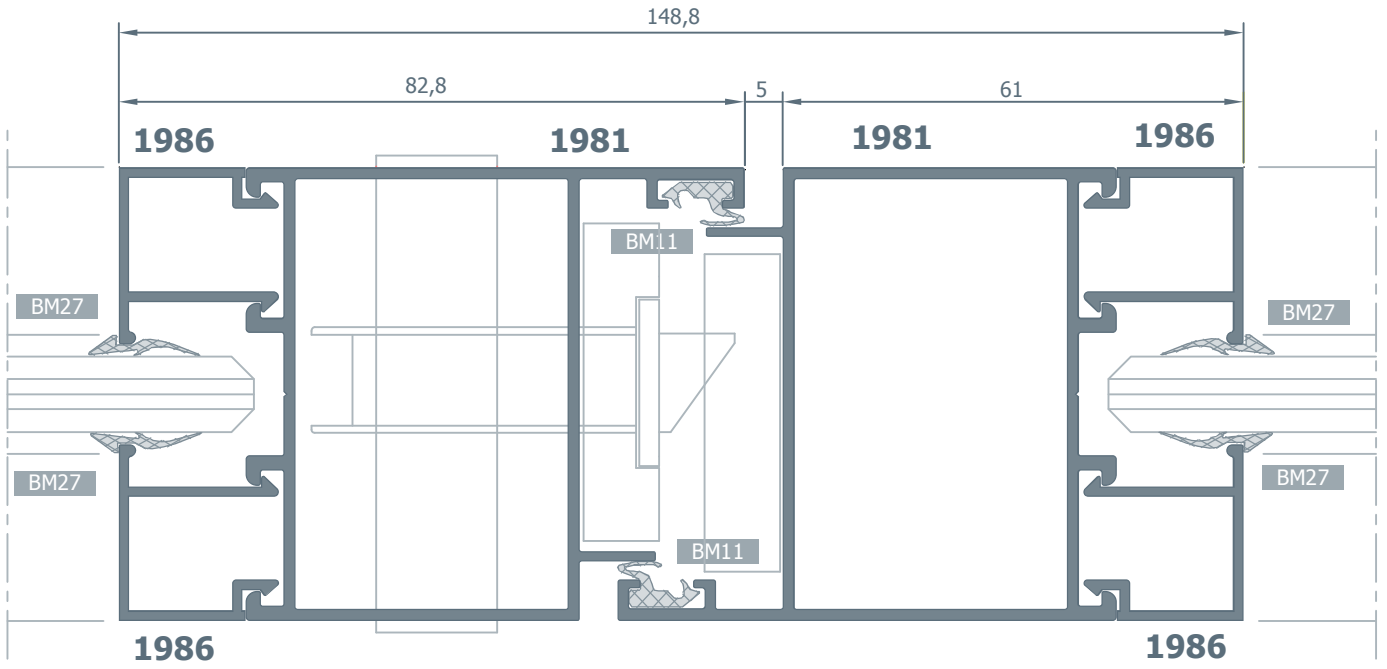

ÇARPMA KAPI KANAT DETAYI

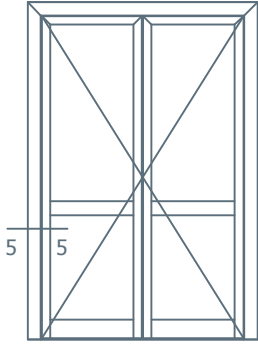
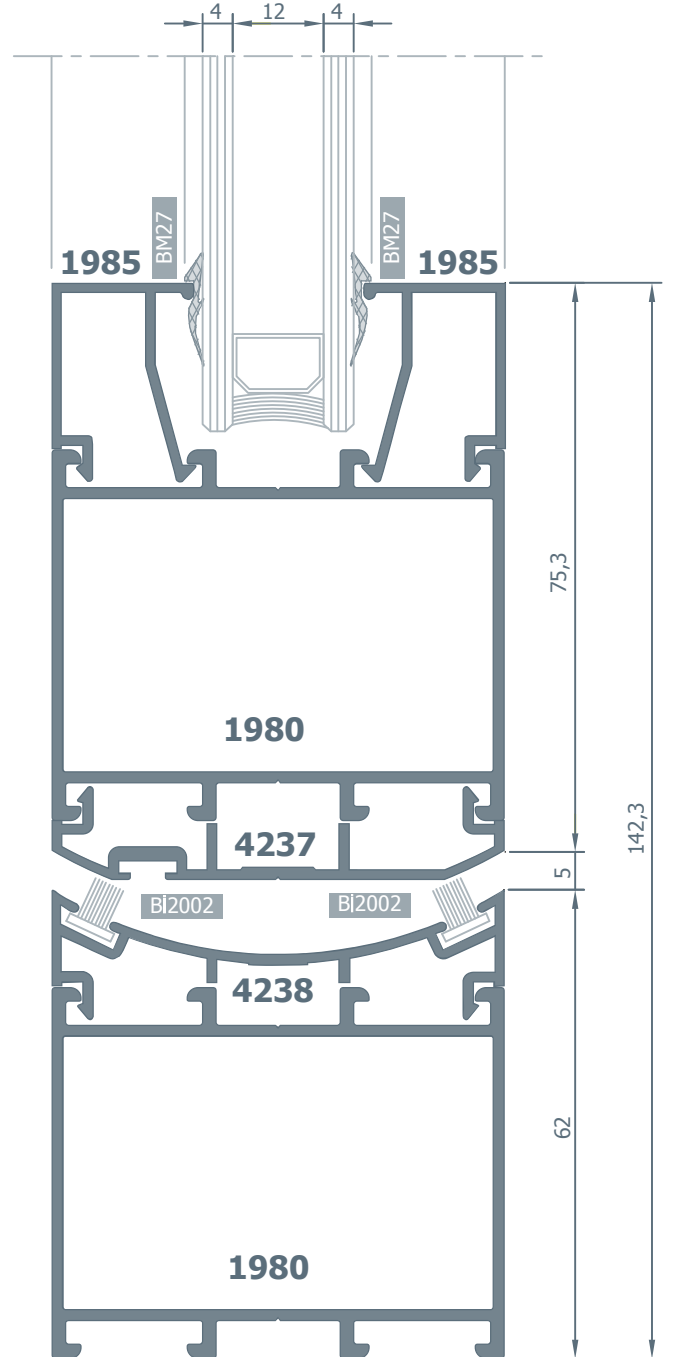
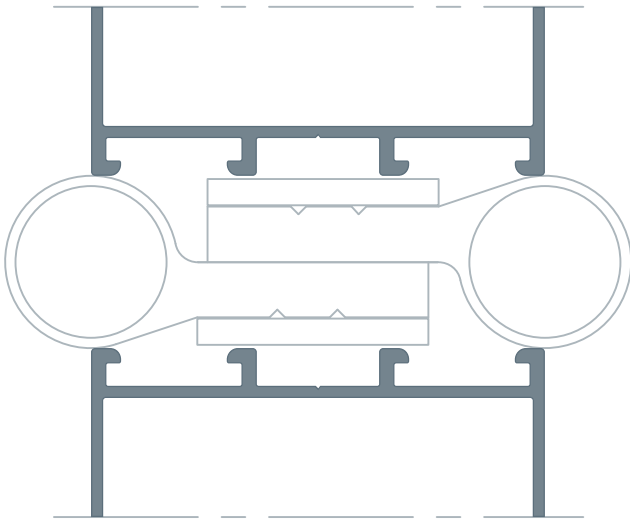
5.5 Detayı
Details

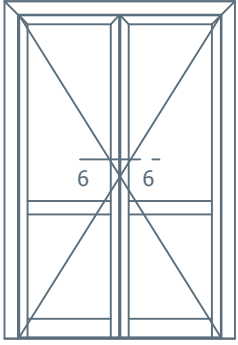

ÇARPMA KAPI KANAT DETAYI

6.6 Detayı
Details

